

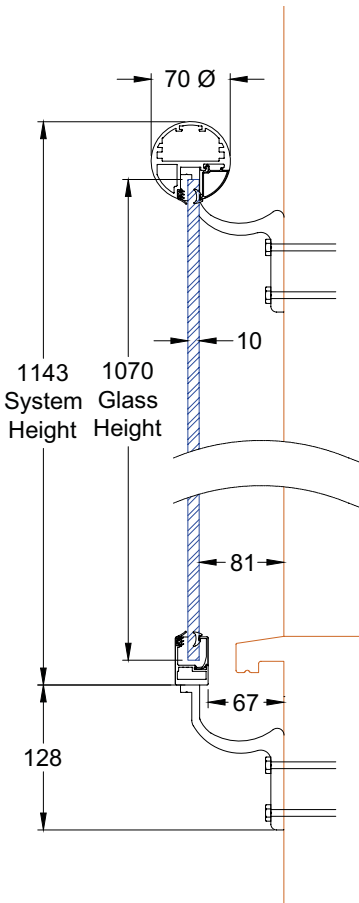

Orbit Juliet Installation Instructions



Important

Before commissioning and before starting installation:

1. Read through these instructions and check that you have all the correct parts of your order.
2. Check the height of the glass or glasses.
3. Check the sizes and height against the required height on site making sure they are correct before assembling.*

*Please note the indicated sizes in this document refer to our standard height of such systems.

*Do not scale from the drawings in this document.

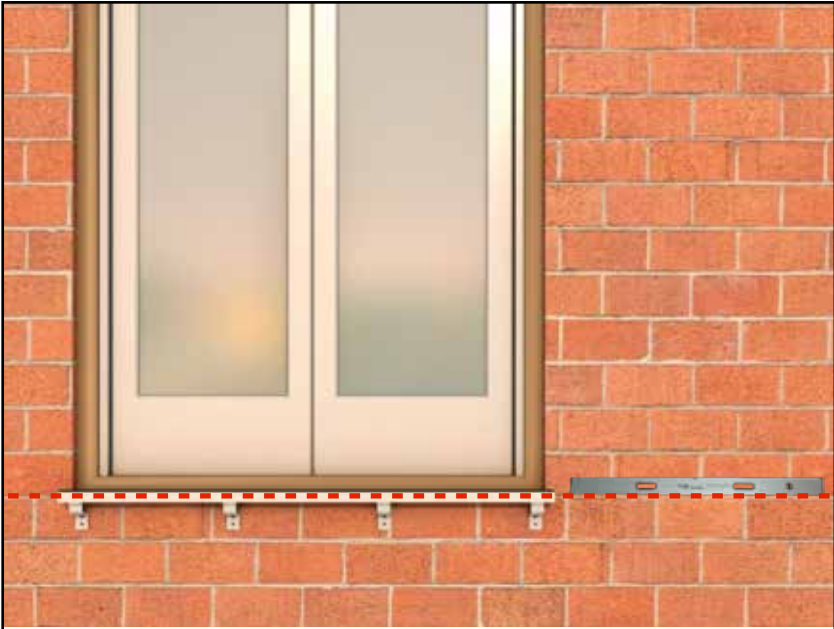

1. Line up bottom track to be level and central with the window opening.



2. Line up bottom track vertically to allow access to the glazing bead from the inside.



3. When properly lined up, fix the bottom track brackets firmly to the wall. (Use a level to make sure it is horizontally level.)

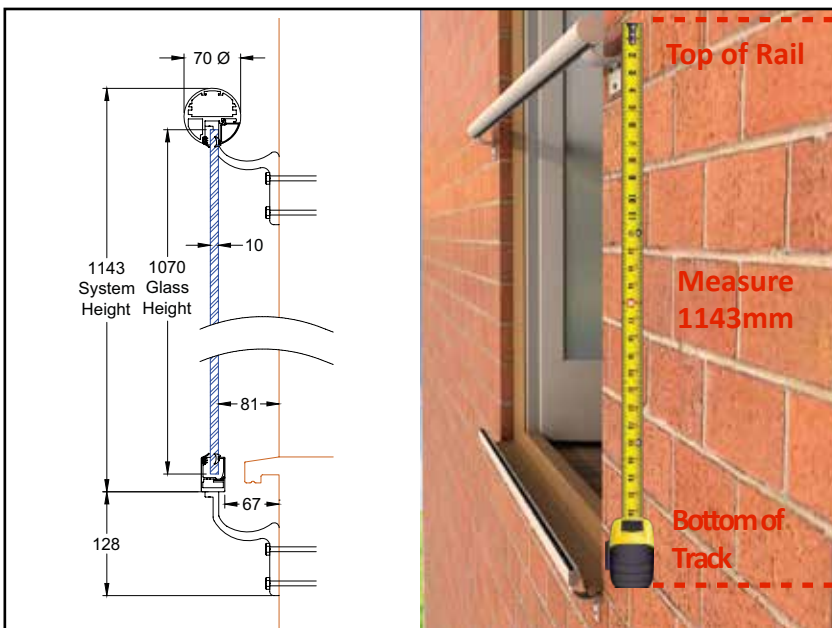

4. Measure the correct height of the handrail position using the above drawing. Do not scale from this drawing. Check that there is 1100mm minimum from inside to top of handrail.



5. Centre the handrail to be central with window giving an equal overlap on both sides.



6. When properly lined up, fix the handrail brackets firmly to the wall.

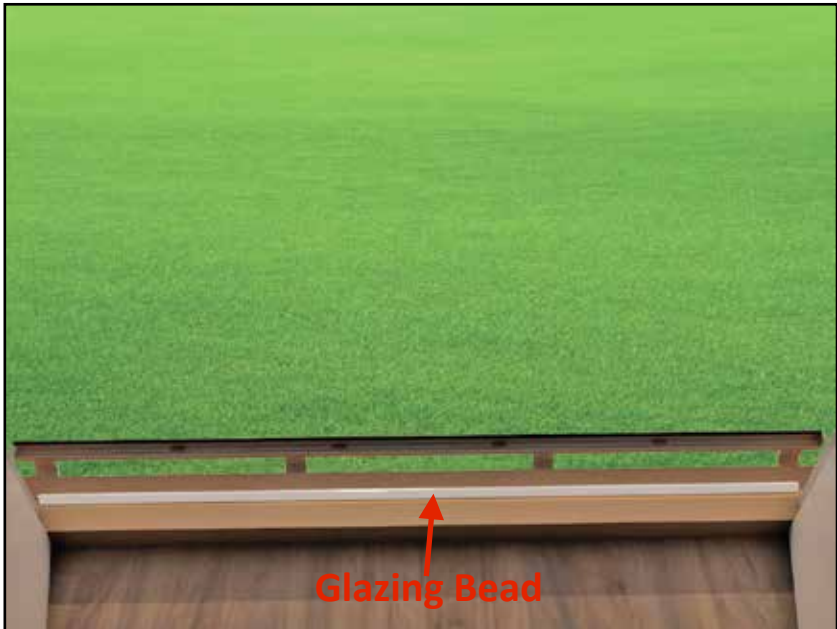

Glazing Bead

7. Remove glazing bead if in place.

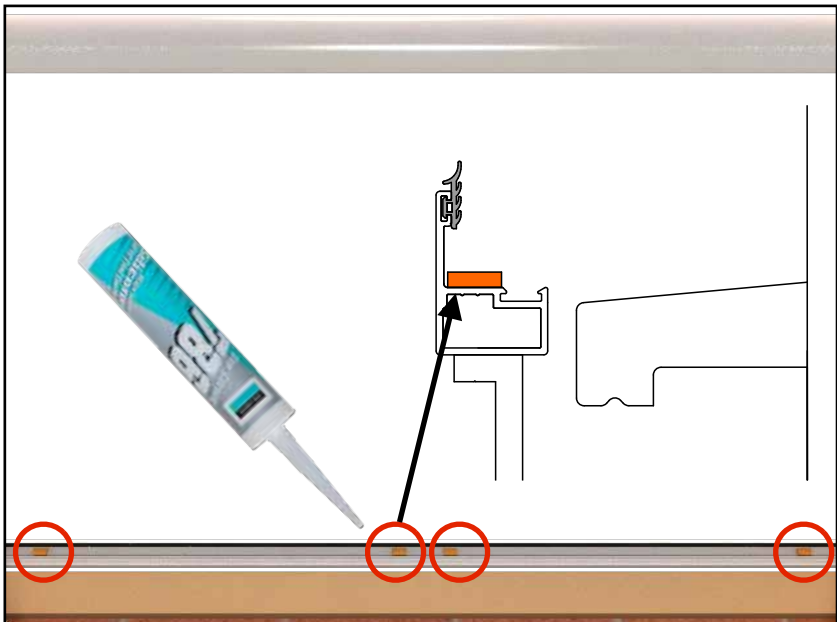

8. Place two spacers on the bottom track for each glass panel and use a dab of silicone to keep them in place.



9. Remove any stickers, writing or spacers that are stuck on the glass.



10. Put the glasses in place by inserting them into the handrail slot and lowering them onto the spacers.

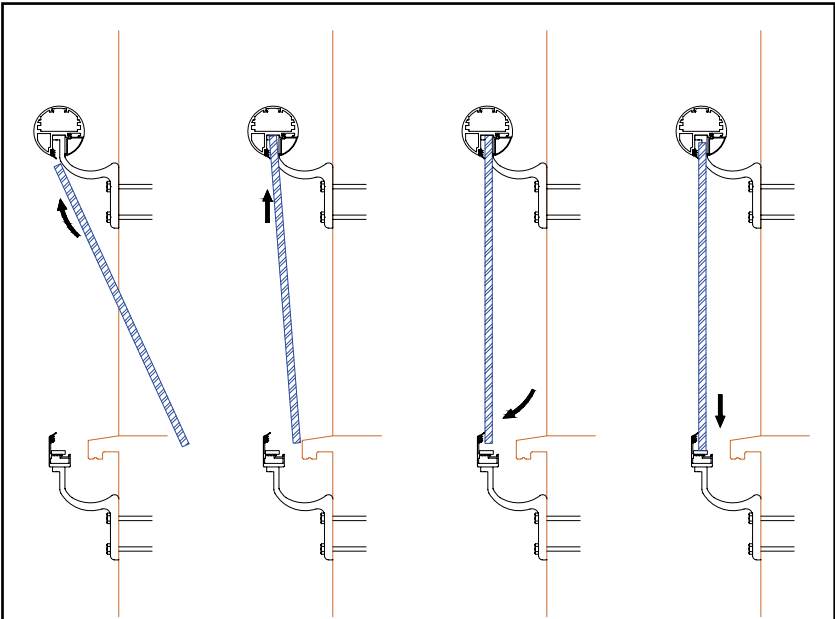

11. Follow these steps to insert the glass panels in place.



12. Replace the glazing bead.



13. Line the glasses up in position so that they are spaced correctly between each other and the wall.

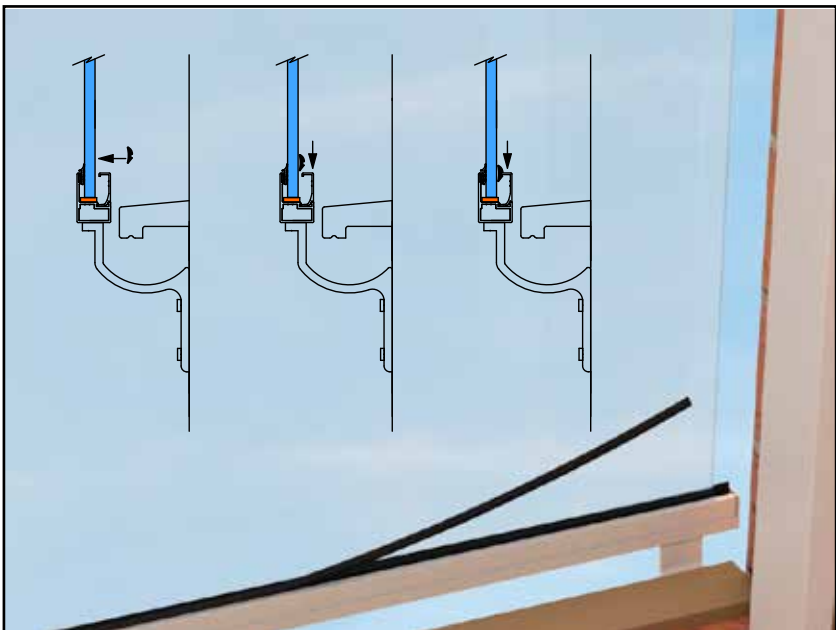

14. Insert the 3mm rubber gasket in the bottom track between the glass and the glazing bead. (Use soap and water to ease the process.)

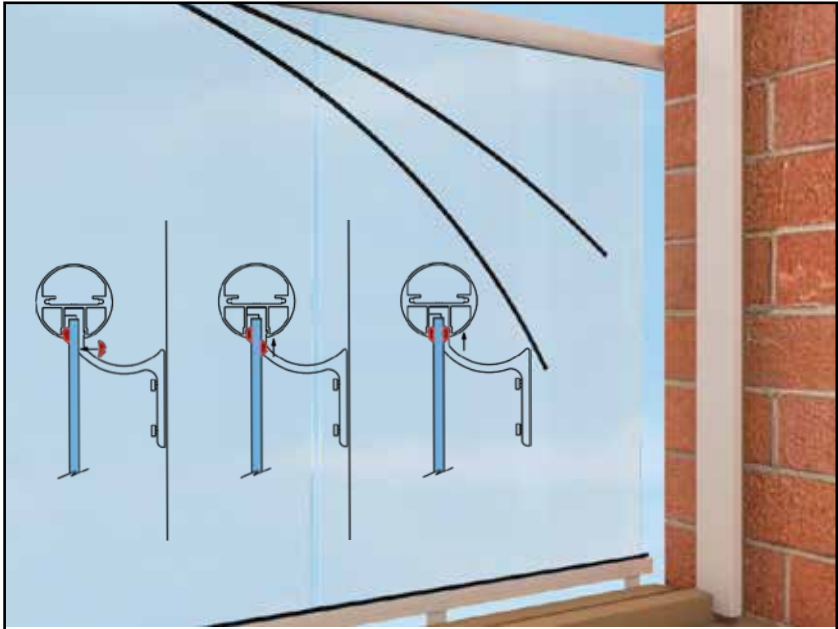

15. Insert the two 3mm rubber gaskets on both sides of the glass in the top handrail. (Use soap and water to ease the process.)



16. Trim off any excess rubber.







Hybrid®

© Balconette 2017

www.balconette.co.uk

01342 410411

Balconette is a trading name of Balcony Systems Solutions Limited.

Registered in England under company registration no. 06937600.

Registered office: Unit 6 Systems House, Eastbourne Road, Blindley Heath, RH7 6JP